

Model ECOM 8

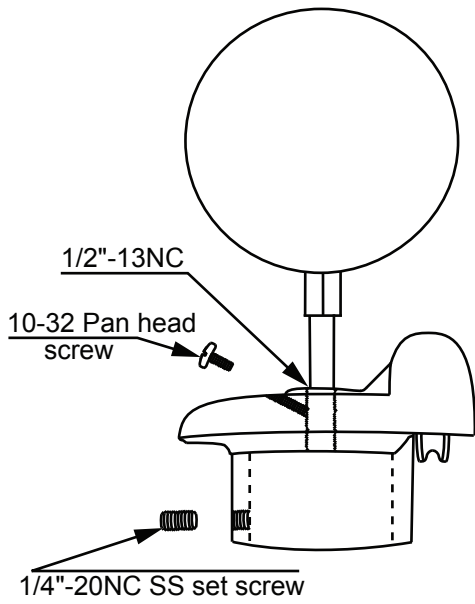

Truck Detail

Cast aluminum construction
 Cast nylon pulley
 3/16" stainless steel axle

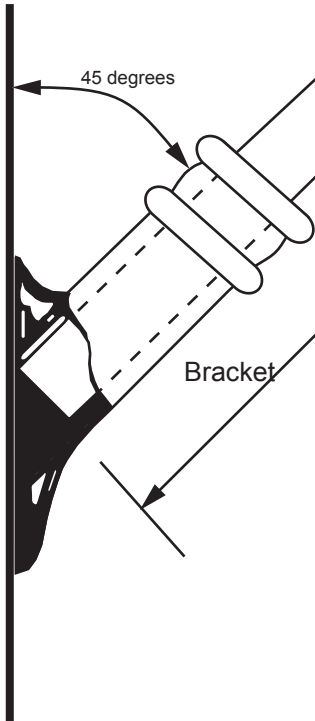
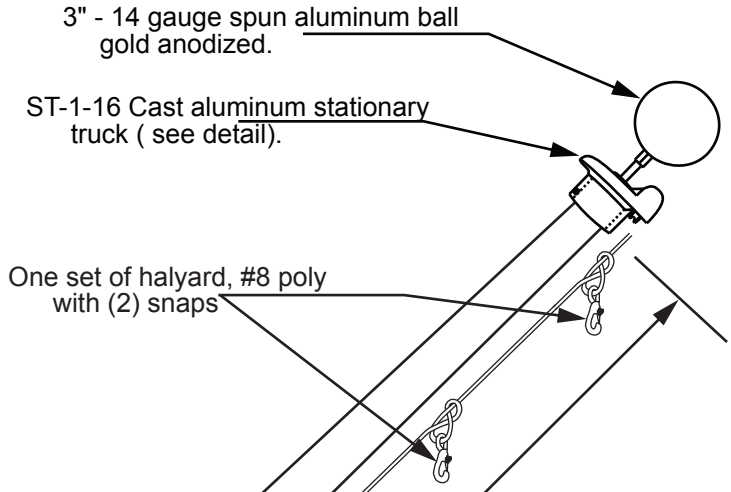

Bracket Detail

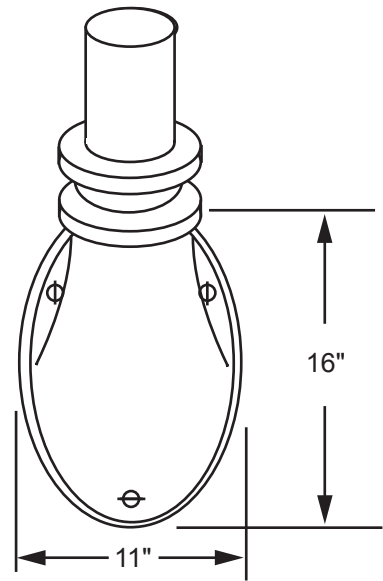

Project:	Ground set tapered aluminum flagpole: ALLOY: 6063T6	EDER FLAG	Date:
Location:	Exposed height: 8'-0"	Overall height: 8'-0"	MANUFACTURING COMPANY
Architect:	Ship in 1 section	Butt diameter: 2-3/8"	1000 W. Rawson Avenue
Contractor:	Top diameter: 1-7/8"	Wall thickness: .140	Oak Creek, WI 53154
Customer:	Finish: 100 grit polish		Job: