

Model ECOST 8

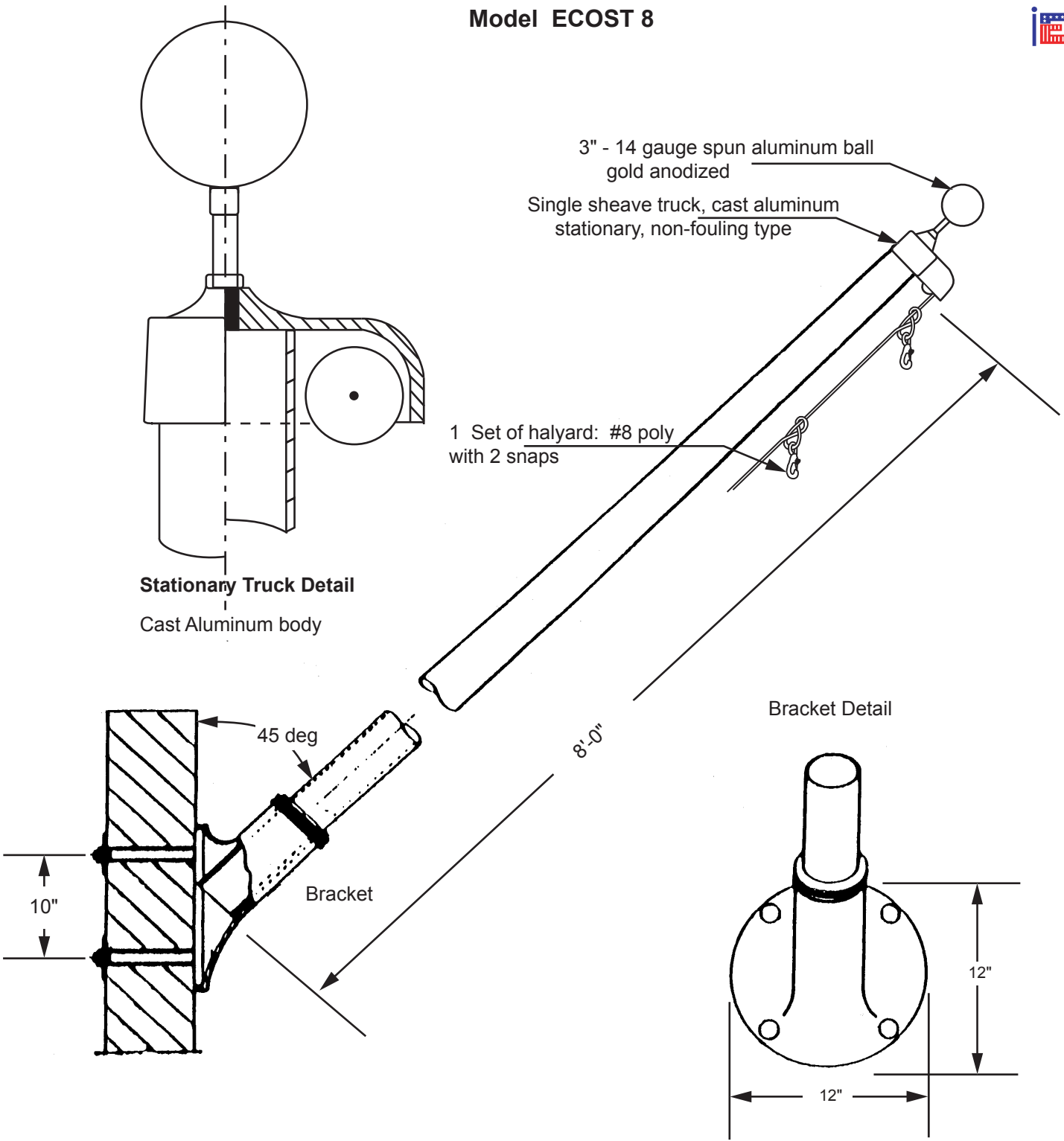

Project:	Cone Tapered Aluminum flagpole: ALLOY: 6063T6	EDER FLAG	Date:
Location:	Exposed height: 8' - 0"	Butt Diameter: 3"	Revision:
Architect:	Ship in 1 section	Top Diameter: 1-7/8"	1000 W. Rawson Avenue
Contractor:	Wall thickness: .125	Oak Creek, WI 53154	
Customer:	Finish: Satin		Job: